



## AirLancer Extender Indoor Antennas





### Range extension and higher performance for office use

- antennas with directional amplification or general extension of radio cell
- antennas for mobile use, at access points or ceiling mount
- complete package including mounting material and cable

LANCOM Wireless Access Points and Client Adapter are already equipped with antennas for basic utilization. In order to achieve better connections and extend range with AirLancer Indoor antennas, Access Points and Client adapters by LANCOM Systems are equipped with connectors for external antennas.

# AirLancer Extender Indoor Antennas

	AirLancer Extender I-60ag	AirLancer Extender I-180
		
<b>Designed for</b>	Dualband Indoor Directional Antenna for up to 100% range extension	Indoor Antenna for practical ceiling mounting
<b>Frequency range</b>	2400 – 2500 MHz (ISM) 5150 – 5875 MHz	2400 – 2483,5 MHz (ISM)
<b>Antenna gain</b>	2.4 GHz, 6 dBi (minus about 2 dB cable loss), 5 GHz, 8 dBi (minus about 3 dB cable loss)	4 dBi (minus about 0.7 dB cable loss)
<b>Range</b>	Up to 100% more	Up to 50% more
<b>E-plane-characteristics</b>	2.4 GHz: 66° horizontal, 79 ° vertical 5 GHz: 55° horizontal, 52 ° vertical	70° horizontal, 360° vertical, 40° downwards
<b>Polarisation</b>	vertical, linear	vertical, linear
<b>VSWR</b>	2.0 : 1	1.8 : 1
<b>Impedance</b>	50 Ohm	50 Ohm
<b>Mounting</b>	table stand with hole for wall mount	installation at lowered ceilings
<b>Dimensions (H x W x D)</b>	75 x 72 x 12 mm	133 x 133 x 42 mm
<b>cable and connector</b>	1.5 m with Reserve-SMA connector for LANCOM Access Points	2 m coax cable, Reverse-SMA-connector for Access Points, proprietary connector for AirLancer adapter
<b>Environmental characteristics</b>	-10°C up to 55°+, to 95% humidity at 25°	-40°C to +80°C, to 99% humidity at 25°C
<b>Optional connections</b>	Direct to the Reverse SMA connector of the main antenna connector of LANCOM Wireless access points. When combining the AirLancer Extender antennas with the OAP Wireless, the supplied cables are not suitable for use with the SMA connector. The access point is supplied with a 1m adapter cable.	
<b>Certifications</b>	The antenna is allowed to be used only with the correspondant cable and LANCOM or AirLancer devices respectively. The complete system is CE conform and can be used in all countries of EU and Switzerland. Complies with: ETS 300 328, ETS 300 826, EN 55022, EN 55024, EN 60950	
<b>Service</b>	Warranty 2 Jahre Support via Hotline and Internet	
<b>Item no.</b>	61214	60914

# AirLancer Extender Indoor Antennas

## AirLancer Extender I-60ag

2.4 GHz: Horizontal Pattern

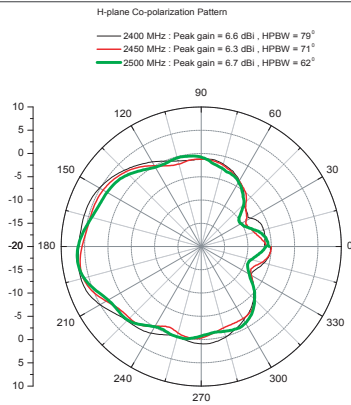

2.4 GHz: Vertikal Pattern

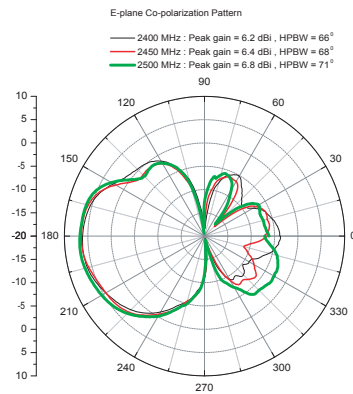

5 GHz: Horizontal Pattern

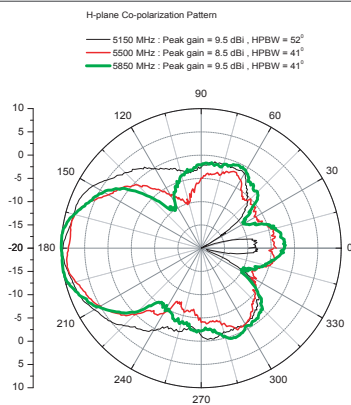

5 GHz: Vertikal Pattern

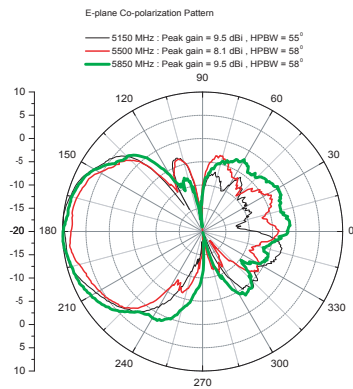

## AirLancer Extender I-180

Horizontal Pattern

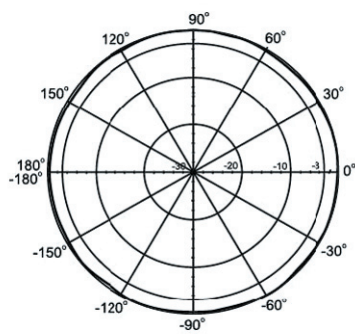

Vertical Pattern

